

# Quick Start Guide

**⚠ WARNING**

- 
1. Hot! Avoid touching the heating nozzle and heating build plate in operation.
- 
2. Moving parts in printer may cause injury. Do not wear gloves or other sources of entanglement in operation.
-



# Creator 3 Pro Quick Start Guide

## Creator 3 Pro Introduction

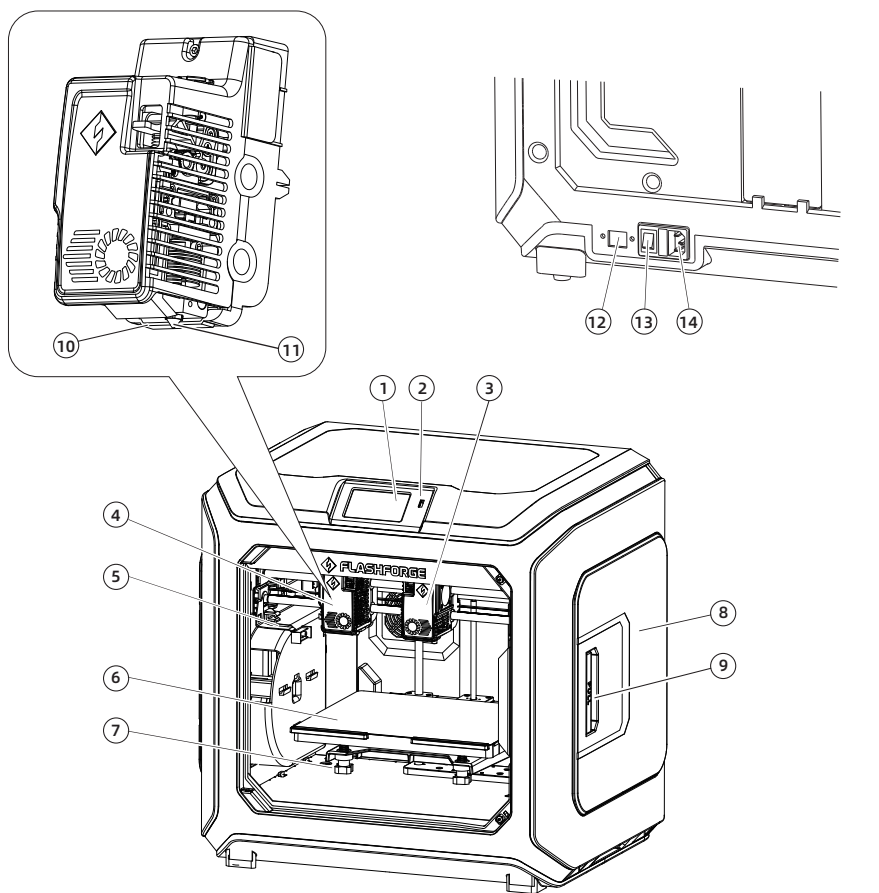

- 1. Touch screen
- 2. USB disk port
- 3. Right extruder
- 4. Left extruder
- 5. The anti-oozing metal plate

- 6. Build plate
- 7. Leveling nut
- 8. Filament holder cover
- 9. Filament holder cover handle
- 10. Wind guide nozzle

- 11. Nozzle
- 12. Ethernet port
- 13. Power switch
- 14. Power cord entry

# Packing List

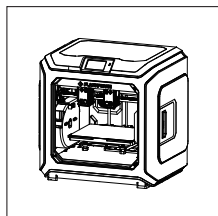

**Creator 3 Pro**

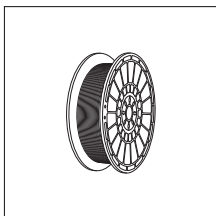

**Filament**

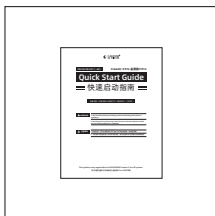

**Quick Start Guide**



**After-sales  
service card**

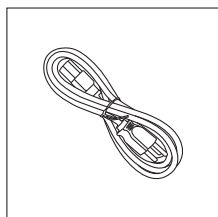

**Power cord**

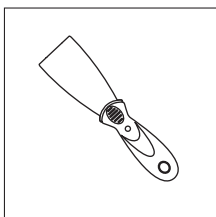

**Scraper**

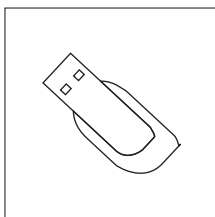

**USB disk**

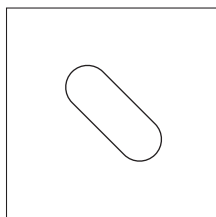

**Leveling card**

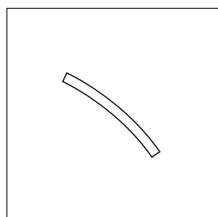

**PTFE tube**

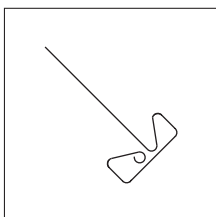

**Unclogging pin tool**

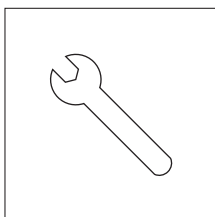

**Stamping wrench**

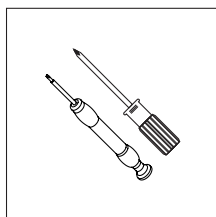

**Screwdriver**

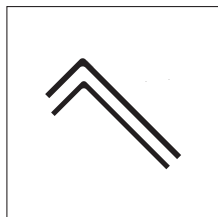

**Allen wrench**

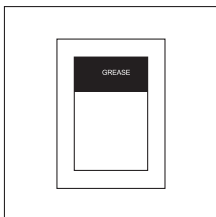

**Lubricating grease**

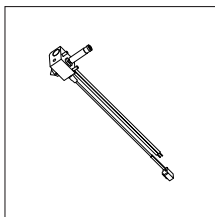

**Nozzle kit**

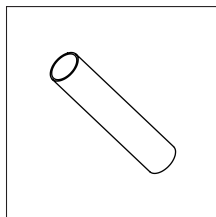

**Nozzle support tube**

## Precautions for Unpacking the Equipment

1. Take out the top accessories and pearl cotton.
2. Remove the tape from the machine.
3. Take out the internal pearl cotton block.

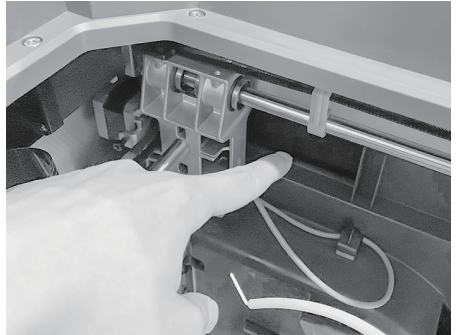
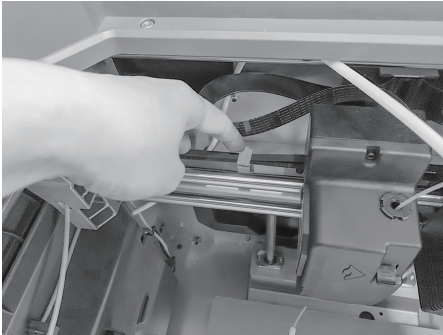

4. Remove the buckles on the X-axis and Y-axis synchronous belts.

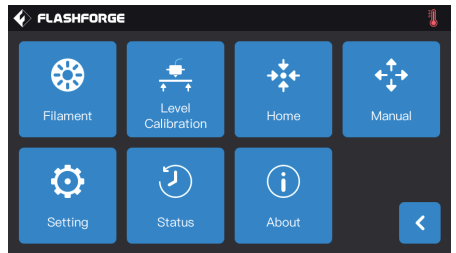
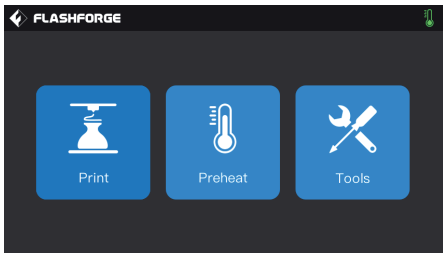

5. Connect the printer to the power supply, after power on, and then click [Tools] and [Manual] in turn on the touch screen to enter the manual control interface.

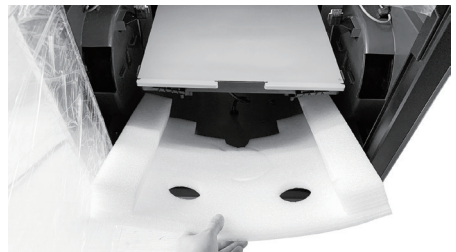
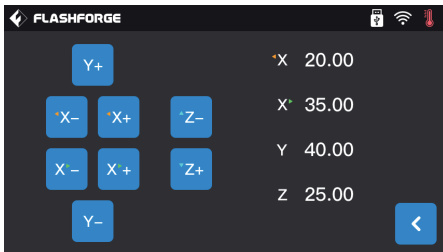

6. Press and hold [Z-] continuously until the build plate rises to a higher position, and then take out the foam block below.

## Preparation for Printing

### Filament Loading

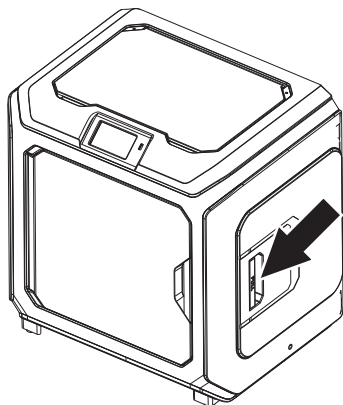

1. Open the filament holder cover.

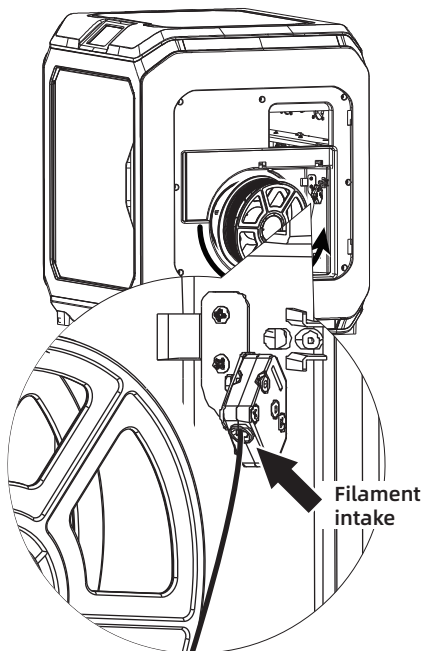

2. Take out the filament and insert it into the filament feeding inlet.

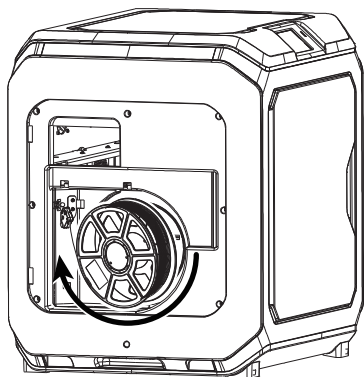

3. Attention: To facilitate smooth rotation of the filament, please install the filament in the direction shown in the figure.

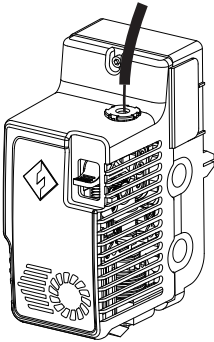

4. Insert the filament into the filament feeding inlet continuously until the filament goes through the filament guide tube.

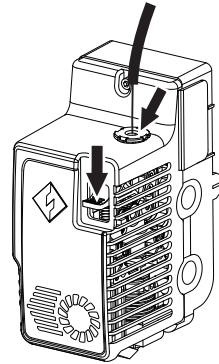

5. Press the filament feeding pressing plate in front of the extruder, insert the filament vertically into the extruder until it can't be inserted any further, and then loosen the filament feeding pressing plate.

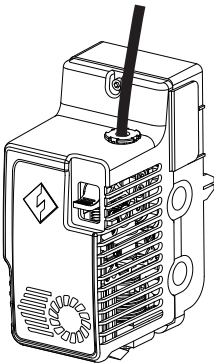

6. Insert the filament guide tube into the filament inlet hole on the extruder to fix.

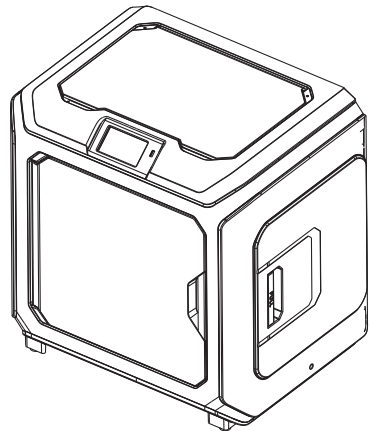

7. Finally, fix the filament spool on the filament spool holder and close the cover.

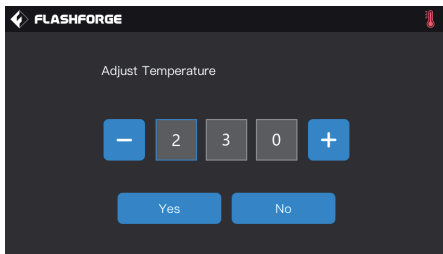
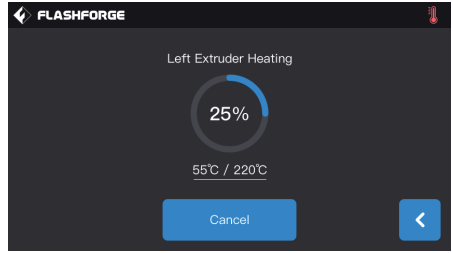
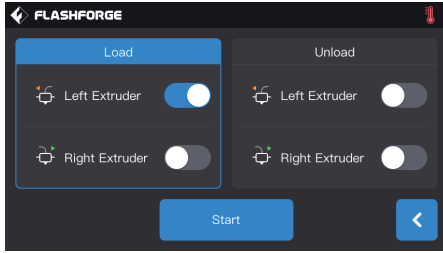
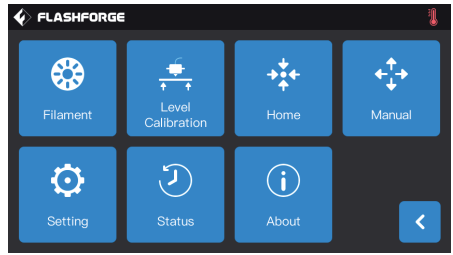
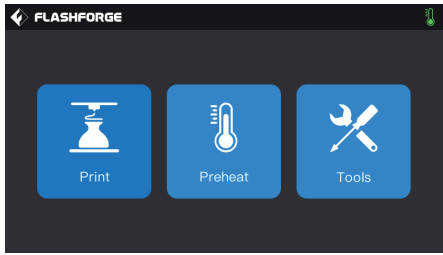

8. Filament feeding operation: Click the [Tools]-[Filament] button on the screen in turn, and set a reasonable heating temperature according to the required temperature value of the material; Operate according to the screen prompts, and wait for the nozzle to extrude uniform filament smoothly.

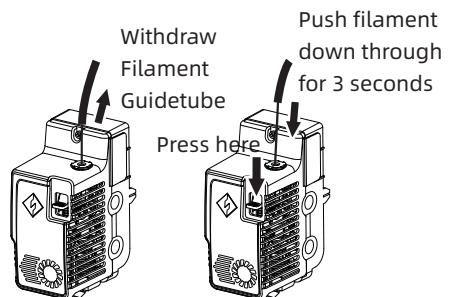
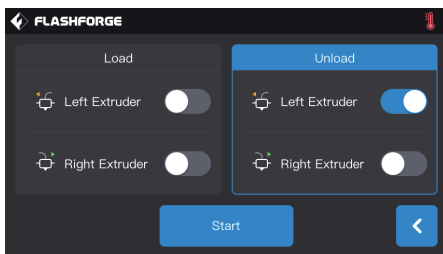

Filament unloading operation: Click [Unload], press down the filament pressing plate after the extruder temperature heating is completed, pull out the white filament guide tube, and pull out the filament upward quickly and then filament unloading is completed.



# Nivellierung und Kalibrierung

Das Gerät wurde vor dem Versand ab Werk nivelliert und kalibriert. Die Nivellierebene kann jedoch infolge von Vibrationen während des Transports beschädigt sein. Es wird eine Nivellierung vor dem ersten Druck empfohlen. Es gibt zwei Nivelliermodi: Hilfsnivellierung und manuelle Nivellierung. Im Modus „Hilfsnivellierung“ werden alle Vorgänge mithilfe des Extrudersensors und unterstützenden Eingabeaufforderungen ausgeführt. Im manuellen Modus aktiviert die Plattformnivellierung im Hilfsmodus keine Sensorfunktion.

Insgesamt ermöglicht das Gerät die folgenden Nivellierkalibrierungen: Bettnivellierung, XY Kalibrierung, Z Kalibrierung und 9-Punkt-Nivellierung.

Behalten Sie bitte die folgenden Reihenfolge bei:

1. Tippen Sie auf dem Touchscreen auf [Tools] und [Nivellieren Kalibrieren].
2. Wählen Sie den Hilfsmodus für die Nivellierung und Kalibrierung.
3. Der Extrudersensor wurde vor dem Versand im Werk kalibriert und muss nicht erneut kalibriert werden. Tippen Sie auf die Plattformnivellierung und befolgen Sie die Bildschirmanweisungen.
4. Nehmen Sie die Kalibrierung der Z-Achse vor und befolgen Sie die Eingabeaufforderungen auf dem Bildschirm.
5. Die X- und Y-Achsen wurden ab Werk kalibriert. Sie müssen daher nicht erneut kalibriert werden.
6. Der gesamten Nivellier- und Kalibriervorgang ist abgeschlossen.

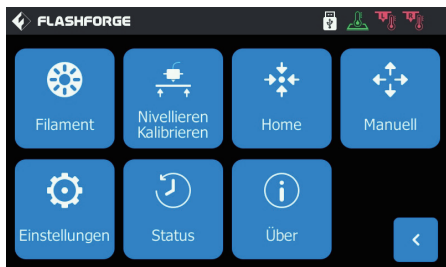

9-Punkt-Nivellierung: Wenn die Flachheit des Druckers nach der Plattformnivellierung und XY/Z-Achskalibrierung weiterhin nicht zufriedenstellend ist, kann diese Funktion verwendet werden, um die Flachheit zu verbessern.



Manuelle Nivellierung: Führen Sie nacheinander die Plattform-Nivellierung, Z-Achskalibrierung und die X-/Y-Achskalibrierung durch. Es handelt sich um einen kompletten Satz der Nivellierung- und Kalibriervorgänge.

# Erster Druck

Vor dem ersten Druck schließen Sie bitte die Nivellierung, das Beladen und die Kalibrierung ab. Ziehen Sie die Schnellstartanleitung hinzu.

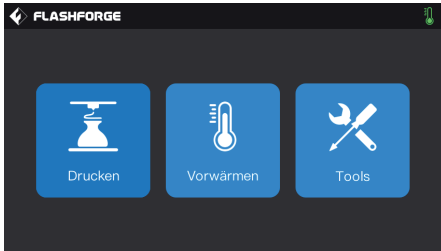

1. Berühren Sie [Drucken] (Konstruktion).

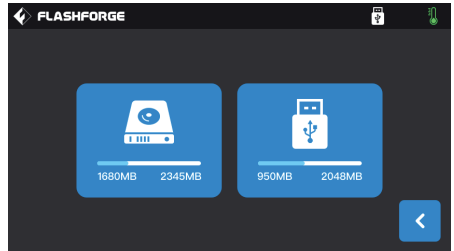

2. Berühren Sie [Local memory] (Lokaler Speicher) für die Auswahl der Druckdateien.

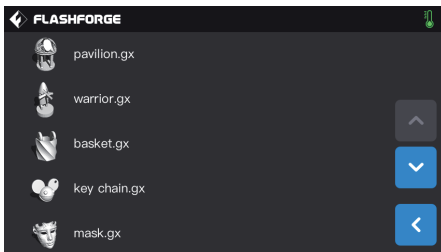

3. Wählen Sie die vorhandene Druckdatei.

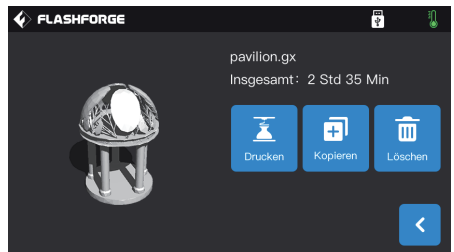

4. Berühren Sie [Drucken] (Konstruktion).

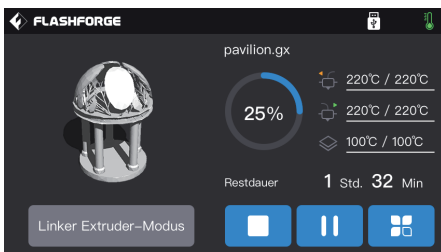

5. Der Drucker wird aufgewärmt und startet den Druck nach dem Ende der Aufwärmphase.

# Creator 3 Pro Guide rapide

## Présentation de la Creator 3 Pro

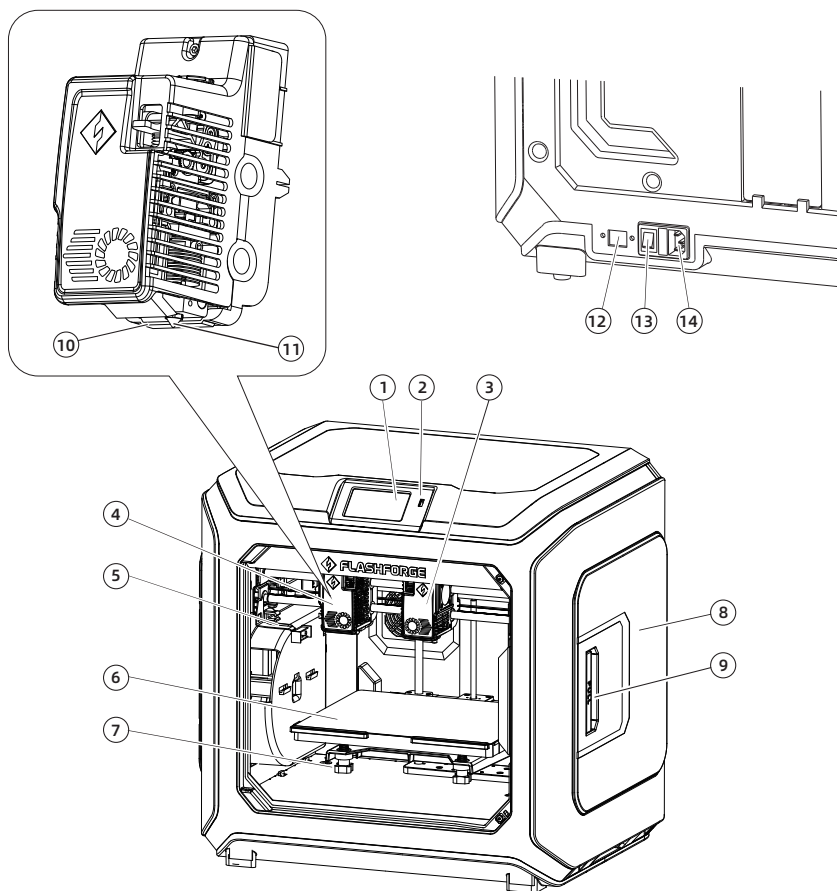

- |                            |  |
|----------------------------|--|
| 1. Écran tactile           | 8. Carter du porte-filament            |
| 2. Port pour disque USB    | 9. Poignée du carter du porte-filament |
| 3. Extrudeuse de droite    | 10. Buse du déflecteur d'air           |
| 4. Extrudeuse de gauche    | 11. Buse                               |
| 5. Plaque anti-pénétration | 12. Port Ethernet                      |
| 6. Plateau                 | 13. Interrupteur marche/arrêt          |
| 7. Écrou de nivellement    | 14. Entrée du cordon d'alimentation    |

## Contenu de l'emballage

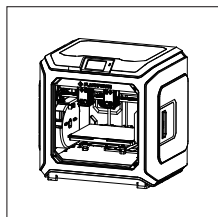

**Creator 3 Pro**

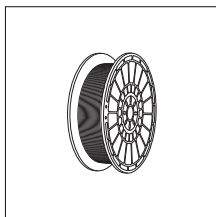

**Filament**

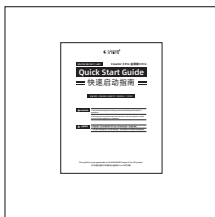

**Guide rapide**



**Carte de service  
après-vente**

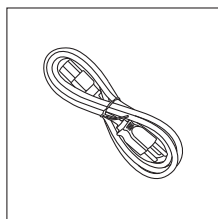

**Cordon  
d'alimentation**

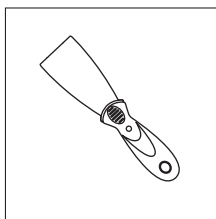

**Grattoir**

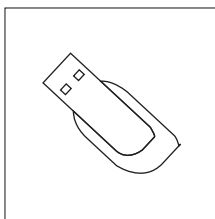

**Disque USB**

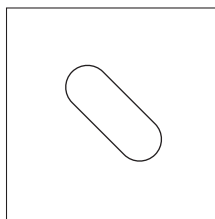

**Carte de  
nivellement**

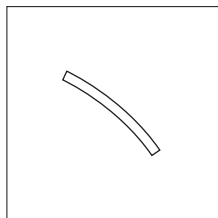

**Tube en PTFE**

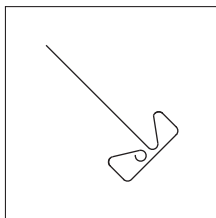

**Poinçon de  
décolmatage**

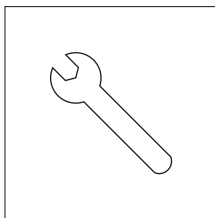

**Clé en acier plat**

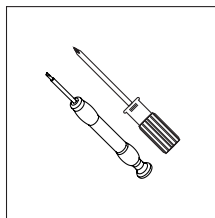

**Tournevis**

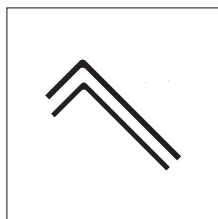

**Clé Allen**

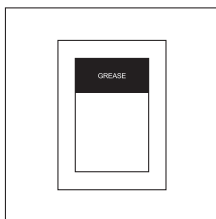

**Graisse lubrifiante**

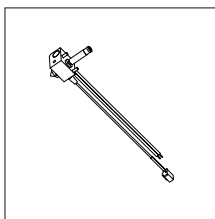

**Ensemble de buse**

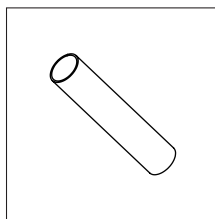

**Tuyau de support  
pour buse**

## Précautions à prendre lors du déballage

1. Retirez les accessoires du dessus et le coton perlé.
2. Décollez le ruban adhésif de la machine.
3. Sortez le bloc de coton perlé de l'intérieur.

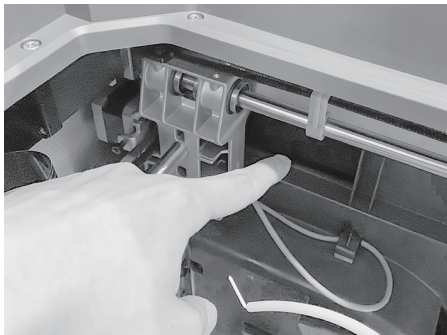
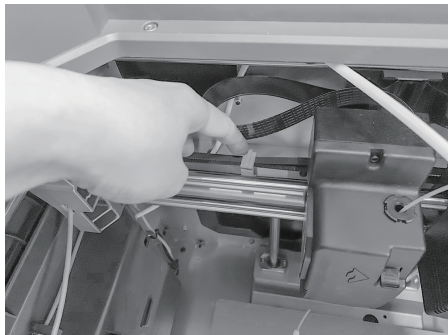

4. Retirez les attaches des courroies synchrones des axes X et Y.

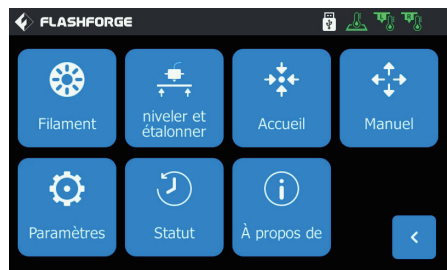
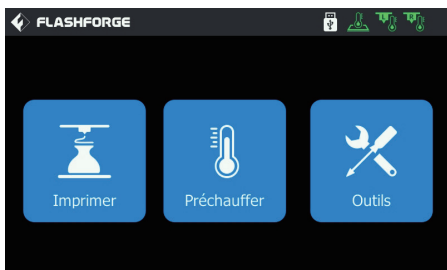

5. Branchez l'imprimante sur le secteur, allumez-la et cliquez sur [Outils] puis sur [Manuel] sur l'écran tactile pour entrer à l'interface de commande manuelle.

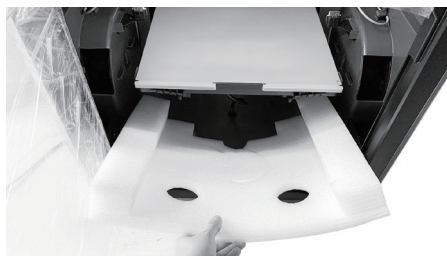
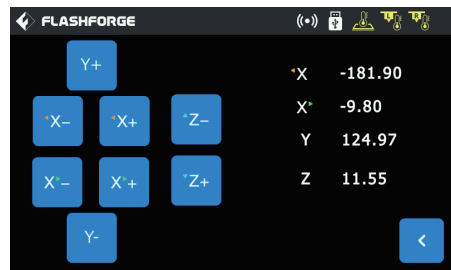

6. Appuyez longuement sur [Z-] jusqu'à ce que le plateau atteigne sa position la plus haute, puis retirez le bloc de mousse du dessous.

## Préparation à l'impression

### Chargement du filament

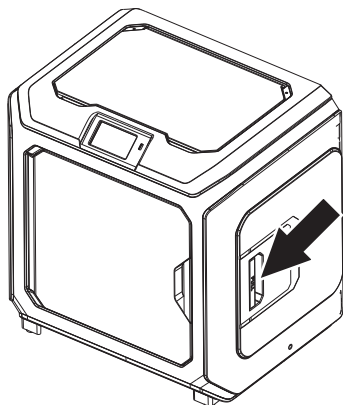

1. Ouvrez le carter du porte-filament.

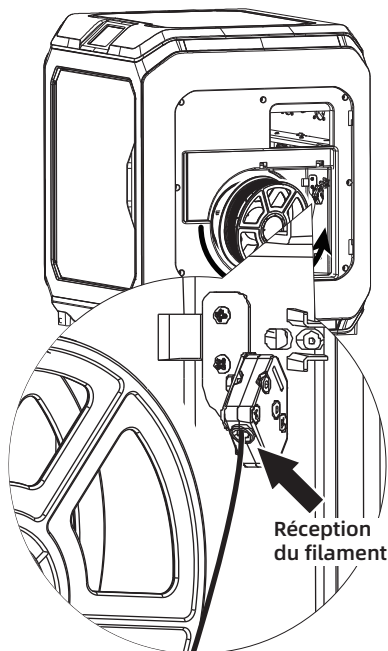

2. Tirez sur le filament et insérez-le dans l'entrée d'alimentation en filament.

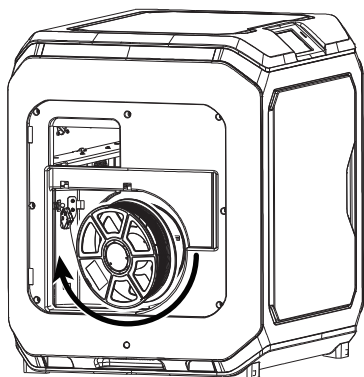

3. Attention : Pour faciliter la rotation libre du filament, installez celui-ci dans la direction illustrée.

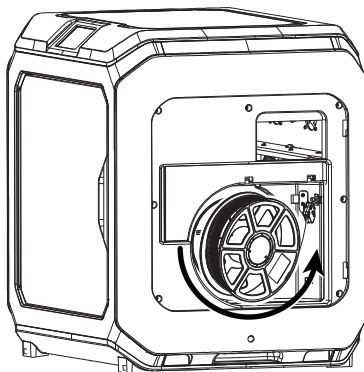

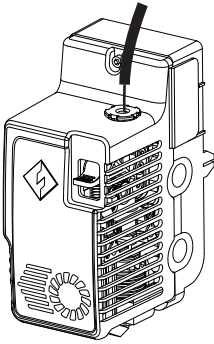

4. Continuez l'insertion du filament dans l'entrée d'alimentation en filament jusqu'à ce qu'il ait traversé le tube de guidage.

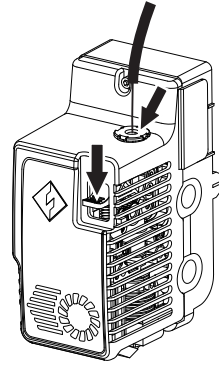

5. Appuyez sur la plaque de pression de l'alimentation en filament située à l'avant de l'extrudeuse, insérez le filament verticalement dans l'extrudeuse jusqu'à ce qu'il bute, puis libérez la plaque de pression.

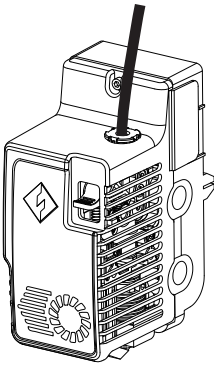

6. Insérez le tube de guidage du filament dans le trou d'entrée de l'extrudeuse pour le fixer.

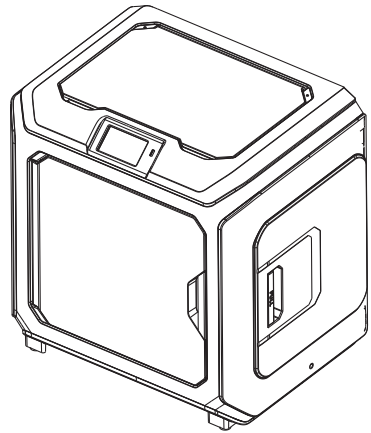

7. Enfin, fixez la bobine de filament sur le porte-filament et fermez le carter.

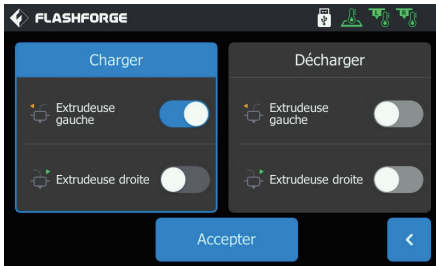
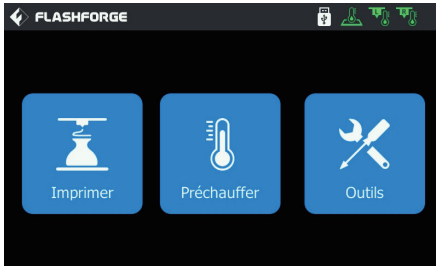

8. Alimentation en filament : cliquez successivement sur les boutons [Outils]-[Filament] de l'écran, puis définissez une température de chauffage raisonnable conformément à la température requise par le matériau. Suivez les invites qui s'affichent, et attendez que la buse extrude sans heurts un filament uniforme.

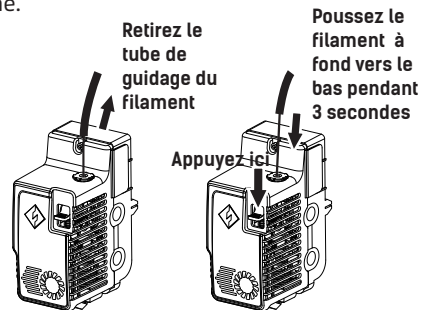
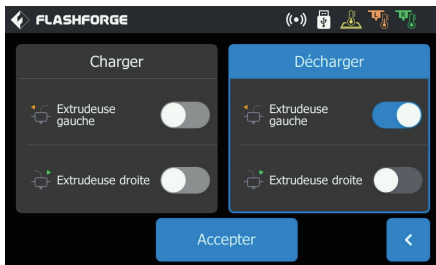

Déchargement du filament : cliquez sur [Décharger], appuyez sur la plaque de pression du filament une fois que l'extrudeuse a atteint la température de consigne, tirez sur le tube de guidage blanc du filament pour le retirer, puis tirez rapidement le filament vers le haut. Le déchargement est alors terminé.



## Nivellement et étalonnage

L'appareil a été nivelé et étalonné en usine. Cependant, le plan de nivellement peut s'être modifié à cause de vibrations pendant le transport. Il est conseillé d'effectuer un nivellement avant la première impression. Il y a deux modes de nivellement : le mode auxiliaire et le mode manuel. Dans le mode auxiliaire, tout se fera avec l'aide du capteur de l'extrudeuse et des invites auxiliaires. Si l'option de fonction est en mode manuel, le nivellement de la plateforme en mode auxiliaire n'active pas la fonction du capteur.

L'appareil demande les étalonnages de nivellement suivants : Nivellement du plateau, Étalonage du XY, Étalonage du Z et Nivellement sur 9 points.

Procédez dans l'ordre suivant :

1. Cliquez sur [Outils] puis sur [Niveler et étalonner] sur l'écran tactile.
2. Sélectionnez le mode auxiliaire de nivellement et d'étalonnage.
3. Le capteur de l'extrudeuse a été étalonné en usine. Il n'est donc pas nécessaire de le refaire. Cliquez sur « Nivellement du plateau » et suivez les invites qui s'affichent.
4. Étalonnez l'axe Z et suivez les invites qui s'affichent.
5. Les axes X et Y ont été étalonnés en usine. Il n'est donc pas nécessaire de les réétalonner.
6. Le nivellement et l'étalonnage sont terminés.



Fonction de nivellement sur 9 points : si après le nivellement de la plateforme et l'étalonnage des axes X, Y et Z la planéité est encore imparfaite, vous pouvez utiliser cette fonction pour l'améliorer.

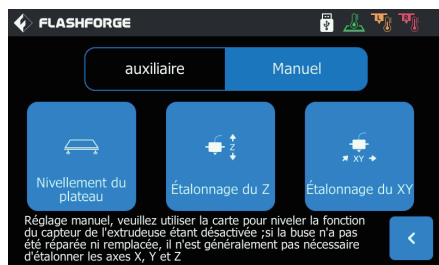

Mode de nivellement manuel : Exécutez successivement le nivellement de la plateforme, l'étalonnage de l'axe Z et celui des axes X et Y. C'est un ensemble complet de procédures de nivellement et d'étalonnage.

## Première impression

Avant la première impression, veuillez achever le calibrage, calibration et chargement du filament correctement.

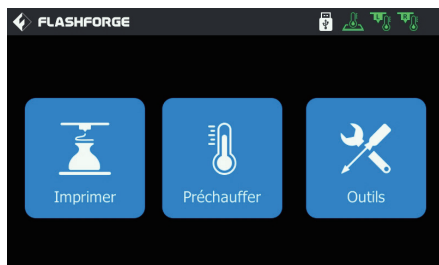

1. Cliquez sur Imprimer.

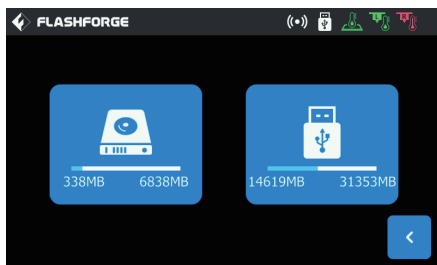

2. Appuyez sur mémoire locale pour choisir les fichiers d'impression.

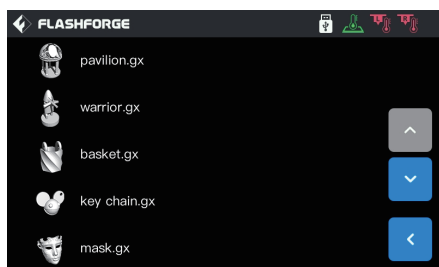

3. Sélectionnez le fichier.

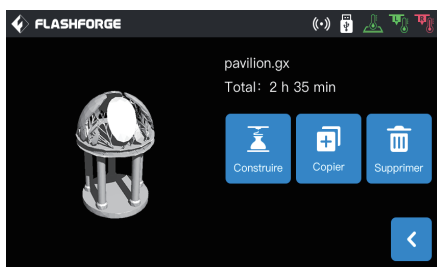

4. Cliquez sur Imprimer.

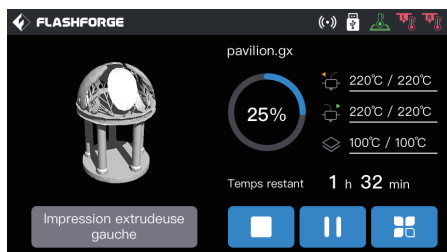

5. L'imprimante commencera à imprimer une fois le chauffage terminé.

# 포장물 리스트

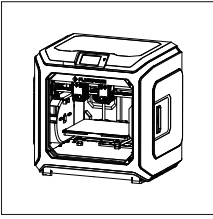

크리에이터3 프로

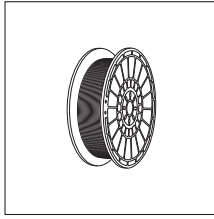

필라멘트

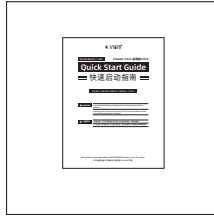

빠른 가이드



애프터 서비스 카드

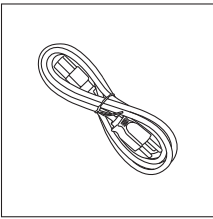

전원 코드

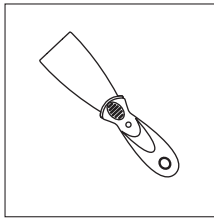

스크래퍼

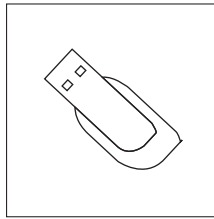

USB 디스크

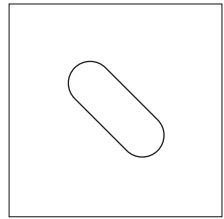

레벨링 카드

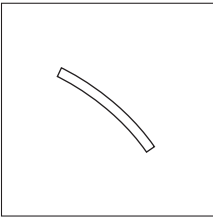

PTFE 튜브

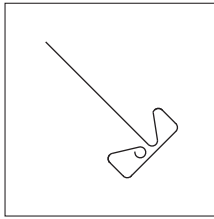

막힘뚫기 핀

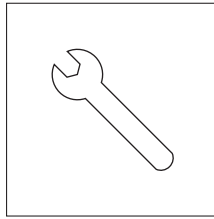

스텝핑 렌치

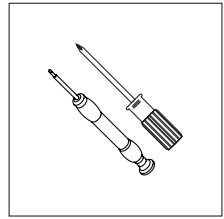

드라이버

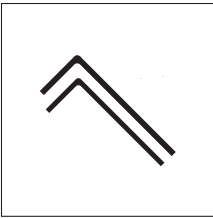

엘런 렌치

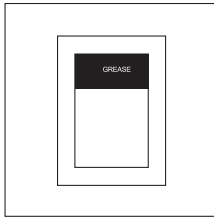

윤활 그리스

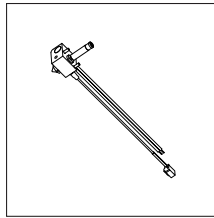

노즐 어셈블리

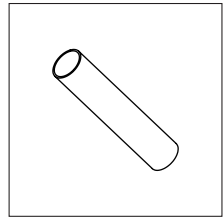

노즐 지지관





Follow us

**Zhejiang Flashforge 3D Technology Co., Ltd.**

Address: No.518 XianYuan Road, Jinhua City, Zhejiang Province, China

Service Hotline: +86 579 82273989

[support@flashforge.com](mailto:support@flashforge.com)